



ITALIAN INNOVATIVE GLASS FIXING

LED LINE

Il nuovo corrimano con illuminazione
The new handrail with lighting



03.6 CORRIMANO CON CAVA - HANDRAIL WITH SLOT

03.6.2 LEDLINE - HANDRAILED

Il nuovo corrimano con illuminazione - The new handrail with lighting

Profilo corrimano scanalato in alluminio per led

Aluminium handrail profile with slot for led

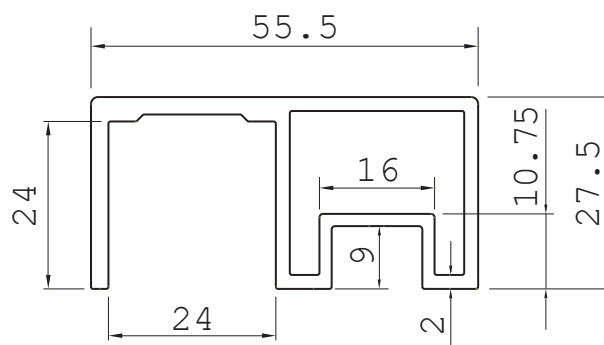

Cod.	Lunghezza	Length
E24C70021	6 m	19' - 8"

Guarnizione in PVC trasparente di copertura led ad incastro

Interlocking transparent PVC gasket for led covering

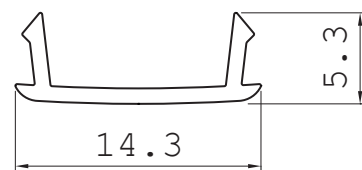

Cod.	Lunghezza	Length
E24C70539	2 m	78 3/4"

Tappi terminali in alluminio

Aluminium end caps

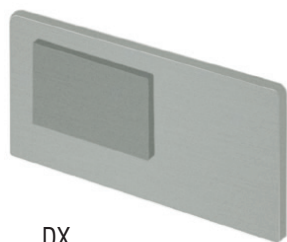

DX

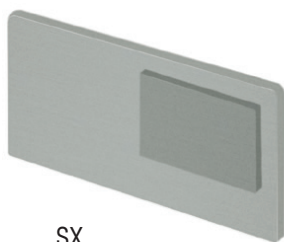

SX

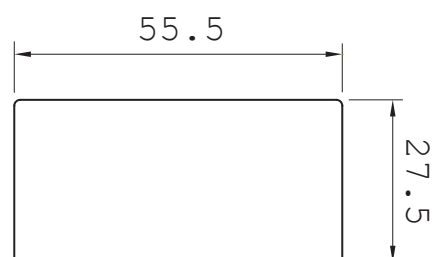

Cod.	verso	side
E24C70101	destro	right
E24C70201	sinistro	left

03.6 CORRIMANO CON CAVA - HANDRAIL WITH SLOT

03.6.2 LEDLINE - HANDRAILED

Il nuovo corrimano con illuminazione - The new handrail with lighting

Guarnizione per corrimano con led in PVC nero

Gaskets for handrail led in black PVC

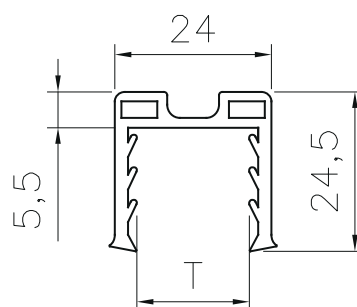

Cod.	Vetro	H	Glass	H
E24C11110	da 8 a 10,76 mm	3/6 m	from 8 to 10.76 mm	3/6 m
E24C11210	da 12 a 16,76 mm	3/6 m	from 12 to 16.76 mm	3/6 m
E24C11310	da 16,76 a 18 mm	3/6 m	from 16.76 to 18 mm	3/6 m
E24C11410	19 mm	3/6 m	19 mm	3/6 m
E24C11510	da 20 a 21,52 mm	3/6 m	from 20 to 21.52 mm	3/6 m
E24C11120	da 8 a 10,76 mm	30 m	from 8 to 10.76 mm	30 m
E24C11220	da 12 a 16,76 mm	30 m	from 12 to 16.76 mm	30 m
E24C11320	da 16,76 a 18 mm	30 m	from 16.76 to 18 mm	30 m
E24C11420	19 mm	30 m	19 mm	30 m
E24C11520	da 20 a 21,52 mm	30 m	from 20 to 21.52 mm	30 m

Striscia Led impermeabile

Waterproof led stripe



OGNI 62,5 MM SONO SEGNATI I PUNTI
DOV'È POSSIBILE TAGLIARE IL NASTRO
EVERY 1/4" YOU FIND MARKS WHERE
YOU CAN CUT THE RIBBON

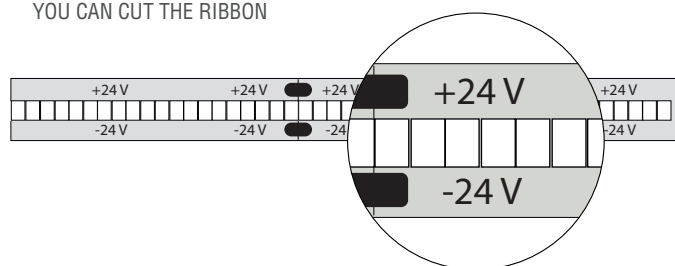

Cod.	Luce	Input voltaggio	Light	Input voltage
E12S30101	calda	24 V	warm	24 V
E12S30102	naturale	24 V	natural	24 V
E12S30103	fredda	24 V	cold	24 V





03.6 CORRIMANO CON CAVA - HANDRAIL WITH SLOT

03.6.2 LEDLINE - HANDRAILED

Il nuovo corrimano con illuminazione - The new handrail with lighting

Connettore di collegamento da striscia led all'alimentatore

Led-stripe power supply connection

B

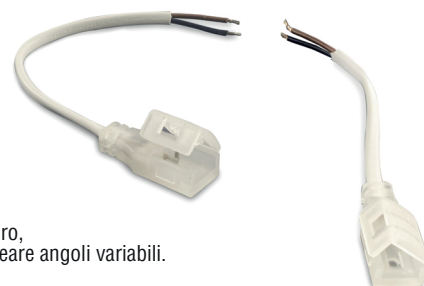

Utilizzando due connettori saldati tra loro, si possono collegare strisce Led per creare angoli variabili.

xxx

Cod.
E12S40100

Connettore di unione tra due strisce led

Connection between two led stripes

C



Cod.
E12S40200

Connettore terminale per striscia led

End connection for led stripes

D



Cod.
E12S40500

03.6 CORRIMANO CON CAVA - HANDRAIL WITH SLOT

03.6.2 LEDLINE - HANDRAILED

Il nuovo corrimano con illuminazione - The new handrail with lighting

Alimentatori

Power supply

A



Cod.	dim.	Potenza	Lunghezza led	Dim.	Power	Led length
E12S50100	190x52x37 mm	100 W	8 m	190x52x37 mm	100 W	8 m
E12S50200	162,5x42,5x32 mm	60 W	5 m	162.5x42.5x32 mm	60 W	5 m
E12S50300	148x40x30 mm	35 W	3 m	148x40x30 mm	35 W	3 m
E12S50400	140x30x20 mm	18 W	1,5 m	140x30x20 mm	18 W	1,5 m

UTILIZZARE UNA PINZA PER FARE PRESSIONE SIA DALL'ALTO CHE NEL BASSO DEI CONNETTORI PER UNIRE LE STRISCE DI LED

USE A CLAMP TO APPLY PRESSURE FROM ABOVE AND BELOW THE CONNECTORS TO JOIN THE STRIPS OF LEDS

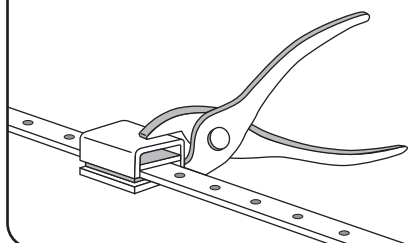

SCHEMA DI MONTAGGIO
INSTALLATION DIAGRAM

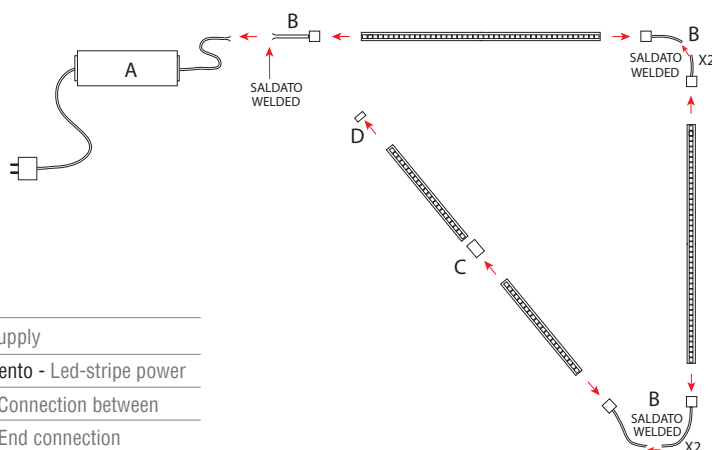

- A Alimentatore - Power supply
- B Connettore di collegamento - Led-stripe power
- C Connettore di unione - Connection between
- D Connettore terminale - End connection

